

Technical manual BA 0809



Water level



GSM – 1000

Remote data transmission module

for measuring value remote data transmission and remote alarming from water level sensors with data memory

- Remote data transmission by wireless GSM communications network
- Remote configuration per PC or mobile phone
- Integrated battery for run times of more than 5 years
- Connection of water level sensors series Hydrolog
- Installation on water level tubes 4" and wider
- Control plumbing by cable light plumblines without deinstallation
- Flood protected up to 3m water column
- Filler cap with integrated antenna
- Password protected access

ACS-CONTROL-SYSTEM
know how mit system



Lauterbachstr. 57 – 84307 Eggenfelden – Germany
Tel: +49 8721/9668-0 – Fax: +49 8721/9668-30
info@acs-controlsystem.de – www.acs-controlsystem.de

Index

Application description	3
Function	3
Operation and data retrieval	4
Operation by SMS command codes	5 / 6 / 7 / 8 / 9
Safety notes	10
Installation	10
Installation and removal of the SIM card	11
Connection of a water level sensor	12
Connection of the antenna	12
Battery change	13
Maintenance	14
Repair	14
Technical data	15
Dimension drawings	16 / 17
Accessories	18

Application description

The module **GSM – 1000** is used for remote data transmission (RDT), remote alarming and for configuration of a connected autonomous water level sensor with data memory series **Hydrolog** by using the wireless GSM communications network.

It can be used e.g. for the automation of the data transmission resp. for alarming at river water levels that are difficultly obtainable or that must be supervised fast and regular in the case of high water to eliminate or to reduce possible risks.

Another case of use can be the realizing of closed-control loops that are installed far away from each other, e.g. to vary automatically the drain of a reservoir due to the water levels of the feeding rivers.

Function

The RDT module is used as connection link between the measuring place with a water level sensor series Hydrolog and e.g. the data processing equipment in the office resp. the operation forces in the case of alarming.

Dependent on the configuration of the RDT module different functions are possible.

These are e.g. the transmission of alarming messages per SMS to mobile phones at the attainment of an preset water level or the regular transmission of the measuring values that are stored in the connected water level sensor to the control station.

Additionally a standby mode e.g. daily for one hour can be set, where the RDT module and also the connected water level sensor can be configured per remote transmission.

The processing of the measuring data's resp. the changing's of the configuration are made by the software Gerätemanager GM – 600 resp. GM – 620.

With one battery a run time of much more than 5 years, dependent on the settings can be achieved. There can be sent more than 3000 SMS or more than 400 data record packets of a fully stored water level sensor can be transmitted. Also possible is a standby time, that means call readiness of the RDT module of more than 400 hours. In the case of an unloaded battery a warning message can be sent to prevent timely from a system stop. The battery change can be made fast and uncomplicated at the top side of the RDT module.

In the RDT module a LCD display for cyclic indication of all relevant measuring place data's is integrated.

A control plumbing with a cable light plumblin can be done without Deinstallation of the RDT module.

The plumblin can be put into the system by a feedthrough opening in the housing with a diameter 16mm.

Integrated over voltage protection modules prevents the destruction of the RDT module caused by atmospheric influences like e.g. thunder strike.

Operation and data retrieval

The setting of the operation parameter and the data retrieval from the water level sensor is operated in combination with the operation and evaluation software Gerätanager GM–600 for PC resp. GM–620 for handheld-PC, alternatively directly per cable or wireless per remote data transmission (RDT) (only data retrieval) to a PC.

The software allows a comfortable and flexible adaption to the various requirements of the respective measurement place.

The software version GM–600 is conceived for a PC with operating system MS WINDOWS® 2000 and higher and allows the configuration of the sensor, reading out the measurement values from the sensor, archival, conversion to an excel-, resp. ASCII-, resp. Hydras3-, resp. Wiski-file, as well as the graphical illustration of the measurement values.

The software version GM–620 is conceived for a handheld-PC with operating system MS WINDOWS® and .NET® Framework, like e.g. MS WINDOWS® Mobile.

For the direct cable bound connection to the RS-232 interface (COM port) of the PC resp. handheld-PC, the interface cable STK–RS–1,75m is used. For the connection to the USB interface of the PC resp. handheld-PC the interface converter STK–USB–1,75m is used.

The interface socket is placed at the top side of the RDT module.

With the software there can be configured four different standby times, telephone numbers, passwords, time, alarm messages, text messages and error activities of the RDT module.

Additionally there can be changed all settings of the connected water level sensor and also the parameters of the prealarm and alarm settings.

The daily data transmission is normally done by the GSM communications network directly to a PC, using of the software GM–600 / GM–620.

As an alternative to the direct operation or data retrieval at the installation place resp. to the data remote transmission per PC, there is the possibility to send measuring values resp. alarming messages as SMS to a mobile phone resp. per email to PC's or also to operate the RDT module per SMS command codes.

By using the hand-held terminal AM-1000 the display of the actual measuring value (control measurement) with date and time as well as a continuous real-time measuring at the place of installation without a PC is possible.

For the data retrieval the software Gerätanager GM–600 / GM–620 builds up a data remote connection with the RDT module, that is in standby mode, and requests the data records that are stored in the water level sensor. The other way is the self-acting transmission of the data form the RDT module to the active software Gerätanager GM–600 / GM–620.

The software Gerätanager GM–600 / GM–620 operates the archival, conversion (into excel-, resp. ASCII-, resp. Hydras3-, resp. Wiski-file) and graphical illustration of the measurement data's.

The settings of the RDT module are protected against unauthorized changing's and can only be changed after the input of the valid password.

Detailed informations to the operation parameter and the operation can be found in the technical manual of the Gerätanager GM–600 resp. GM–620.

Operation by SMS command codes

Using SMS command codes the settings of the RDT module and of the alarm management of the connected water level sensor can be read out or changed.

The RDT module can receive SMS messages only in the standby mode. SMS messages that are sent to the RDT module while it is not in the standby mode, are stored intermediately from the respective net provider. At the next log-on, that means at the beginning of the next standby mode the messages are transmitted.

At a request or for setting of parameters a SMS message is sent to the RDT module that contains the respective commands.

The RDT module executes the command and sends back the requested data's or a confirmation per SMS message.



The return of the requested data's or the confirmation per SMS message can only be carried out, if the line identification presentation in the mobile phone of the user is activated. Only by this the RDT module gets the telephone number, to which the return should be executed.

Detailed informations to the activation of a standby mode of the DFÜ-module can be found in the technical manual of the Gerätemanager GM–600 resp. GM–620.

Function example for standby mode and SMS messages

Default

Standby time daily, at 8.00 o'clock, duration 2 minutes

Result

By setting a daily standby time of 2 minutes, every day at 8.00 o'clock, the RDT module log-on every day at 8.00 o'clock to the GSM network at the respective provider and checks, if new SMS messages are available.

Possibilities

If there is now a SMS message available, where a standby time of e.g. 30 minutes is enforced and where also a state message should be sent, the operator will be informed about the beginning of the standby mode. Within the next 30 minutes the user can operate RDT module and alarm management per SMS command codes. Thus, battery capacity can be saved, because a short standby time is enough to request SMS messages, although the measurement system is relatively short-term operateable per RDT. Of course, such a SMS message request can be executed repeatedly per day

Function example for alarm mode and SMS command codes

Default

Standby time at alarm event, duration 30 minutes, state1 SMS sent to default telephone number

Result

At exceeding a preset alarm limit value the RDT module is set to standby mode for 30 minutes. Additionally a predefined state SMS is sent to a preset telephone number.

Possibilities

The owner of the telephone number can now request regularly within the next 30 minutes measuring values per SMS command codes und thus he is constantly up to date.

Additionally he can prolong the standby time when required, to be able to request measuring values after the first 30 minutes.

At a longer standby time the battery capacity of the RDT module can also be requested, to go to the measurement place by the time for a battery change.

Operation by SMS command codes

The SMS command code must follow a predefined syntax. These consists of the password of the RDT module and the command, separated by a semicolon (dash-dot).

Multiple commands, separated by a semicolon, could be included in one SMS message.

The SMD command code is finished by a final semicolon.

If there is no password defined for the RDT module, a semicolon must be set ahead the first command.

To read out data's from the connected water level sensor, the RDT module needs the password of the water level sensor, if defined. This password can be sent to the module by the command code SHPW and must be done only once..

Syntax with password: **password;command code1;command code2;command code3;**

Syntax without password: **;command code1; command code2;command code3;**

Syntax of the standby times

The syntax of the standby times consists of the single parameter of the standby time

Syntax: password;SSB1 ... SSB4=<start time>, <interval>, <duration>,<PC>,<state1>,<state2>;

start time	JJJJ-MM-TT hh:mm:ss (date / time separated by blank character)
interval	interval in minutes
duration	duration in minutes
PC resp. state1/2	
	0 → PC data transmission off / no state SMS
	1 → PC data transmission on / send state SMS

The response to a request of a deactive standby time, e.g. ;GSB2 is e.g. SB2=OFF
To switch-off a standby time e.g. ;SSB1=OFF; must be sent → response SSB1=OK

SMS message dummy

Various parameter can be described by use of dummies, e.g. at defining the state messages

%n	Measuring place name
%v	Current water level measuring value water level sensor
%t	Current temperature measuring value water level sensor
%g	Current temperature RDT module
%b	Remaining battery capacity RDT module
%s	Signal strength RDT module
%d	Date and time

Error state

By the SMS command code GERS the reason can be found, why data's from the connected water level sensor can not be read out.

ERS=2	Communication error water level sensor
ERS=4	Wrong password water level sensor

Error messages

The RDT module responses with error messages, if SMS command codes are wrong or actions could not be executed. By the following SMS command code GERS it can be diagnosed, why data's from the connected water level sensor can not be read out.

Error 3	The transmitted password of the RDT module is wrong
Error 4	Transmitted value exceeds the permitted range of the parameter (e.g. at standby time ≤ 2 minutes)
Error 100	Communication error between RDT module and water level sensor
Parse Error	SMS command code wrong or incomplete

Operation by SMS command codes

Example 1

The password of the RDT module is 123456789. The signal quality should be requested..

SMS message: 123456789;GSQ;
Response: SQ=67
Result: The signal quality is 67%

Example 2

No password is defined for the RDT module. The standby time 4 should be requested.

SMS message: ;GSB4;
Response: SB4=2008-04-27 08:00:00,10080,5,0,1,0;
Result: Standby time 4 is activated, start time is 27.04.2008 at 08.00 o'clock.
Interval time 10080 minutes (= 1 week), standby duration 5 minutes.
PC data transmission deactive, state1 SMS active, state2 SMS deactive

Example 3

The password of the RDT module is 123456789. The telephone number 1 should be requested, telephone number 5 should be set to 016045678901 and date / time should be set to 08. May 2008 10.05.30 o'clock.

SMS message: 123456789;GTN1;STN5=016045678901;SCLK=2008-05-08,10:05:30;
Response: TN1=016098765432;STN5=OK;SCLK=OK;
Result: The telephone number 1 is 016098765432.
The change of telephone number 5 resp. date and time is confirmed

Example 4

The password of the RDT module is 123456789. The module should be set to an enforced standby mode for 2 hours (=120 minutes). The state SMS should be sent.

SMS message: 123456789;SFSB=120;CSST1;
Response: SFSB=OK;
Result: The RDT module is as of now for the next two hours in standby mode.
The state SMS 1 is sent to the telephone number 1 for state SMS.

Example 5

The password of the RDT module is 123456789. An alarming message from the module was received per SMS message. An acknowledgement should be sent.

SMS message: Alarm measurement place Thames 119, measuring value 8,54 mW, temperature 19,3 °C
Command: 123456789;CACK;
Result: The alarming message is confirmed and thus no further alarming messages will be sent.

Example 6

No password is defined for the RDT module. The standby time 2 should be set with start time 07.4.2008 at 17.25 o'clock. The interval time is 1440 minutes (= 1 day) with standby duration 3 minutes.
PC data transmission active, state1 SMS deactive, state2 SMS active

SMS message: ;SSB2=2008-4-07 17:25:00,1440,3,1,0,1;
Response: SSB2=OK
Conclusion: The activation and the setting of the standby time 2 is confirmed.
Note: For a single standby time at a defined start time, this can be achieved by setting the interval time to a very high value, e.g. 99 weeks.

Listing – get-commands

GVER get version
 GSER get serial number
 GERS get error status
 GCMV get current measure value
 GBCAP get battery capacity
 GBWP get battery warning percentage
 GTEM get temperature RDT module in °C
 GSQ get signal quality in %
 GOPN get provider name
 GBAT get battery
 GTN1 get 1st telephone number
 GTN2 get 2nd telephone number
 GTN3 get 3rd telephone number
 GTN4 get 4th telephone number
 GTN5 get 5th telephone number
 GTN6 get 6th telephone number
 GTN7 get 7th telephone number
 GTN8 get 8th telephone number
 GTNS1 get telephone number status SMS 1
 GTNS2 get telephone number status SMS 2
 GTNSC get telephone number service centre
 GTNP1 1st telephone number GSM data transfer to PC
 GTNP2 2nd telephone number GSM data transfer to PC
 GCLK get clock
 GSB1 get 1st standby
 GSB2 get 2nd standby
 GSB3 get 3rd standby
 GSB4 get 4th standby
 GFSB get forced standby
 GSBA get standby alarm
 GSBP get standby prealarm
 GGPW get RDT module password
 GHPW get water level sensor password
 GST1 get status text 1
 GST2 get status text 2
 GLBT get low battery text
 GUPOT get upper prealarm overrun text
 GUPUT get upper prealarm underrun text
 GUAOT get upper alarm overrun text
 GUAUT get upper alarm underrun text
 GLPUT get lower prealarm underrun text
 GLPOT get lower prealarm overrun text
 GLAOT get lower alarm overrun text
 GLAUT get lower alarm underrun text
 GAMIH get alarm measuring interval high
 GAMIL get alarm measuring interval low
 GAFH get alarm filter high
 GAFL get alarm filter low
 GALH get alarm limit high
 GALL get alarm limit low
 GAHH get alarm hysteresis high
 GAHL get alarm hysteresis low
 GALHT get alarm limit high temperature
 GALLT get alarm limit low temperature
 GAHHT get alarm hysteresis high temperature
 GAHLT get alarm hysteresis low temperature
 GPMIH get prealarm measuring interval high
 GPMIL get prealarm measuring interval low
 GPFH get prealarm filter high
 GPFL get prealarm filter low
 GPLH get prealarm limit high
 GPLL get prealarm limit low
 GPHH get prealarm hysteresis high
 GPHL get prealarm hysteresis low

Listing – set-commands

SBCAP	set battery capacity
SBWP	set battery warning percentage
STN1	set 1st telephone number
STN2	set 2nd telephone number
STN3	set 3rd telephone number
STN4	set 4th telephone number
STN5	set 5th telephone number
STN6	set 6th telephone number
STN7	set 7th telephone number
STN8	set 8th telephone number
STNS1	set telephone number status 1
STNS2	set telephone number status 2
STNSC	set telephone number service centre
STNP1	set 1st telephone number GSM data transfer to PC
STNP2	set 2nd telephone number GSM data transfer to PC
SCLK	set clock
SSB1	set 1st standby
SSB2	set 2nd standby
SSB3	set 3rd standby
SSB4	set 4th standby
SFSB	set forced standby
SSBA	set standby alarm
SSBP	set standby prealarm
SGPW	set RDT module password
SHPW	set water level sensor password
SST1	set status text 1
SST2	set status text 2
SLBT	set low battery text
SUPOT	set upper prealarm overrun text
SUPUT	set upper prealarm underrun text
SUAOT	set upper alarm overrun text
SUAUT	set upper alarm underrun text
SLPUT	set lower prealarm underrun text
SLPOT	set lower prealarm overrun text
SLAOT	set lower alarm overrun text
SLAUT	set lower alarm underrun text
SAMIH	set alarm measuring interval high
SAMIL	set alarm measuring interval low
SAFH	set alarm filter high
SAFL	set alarm filter low
SALH	set alarm limit high
SALL	set alarm limit low
SAHH	set alarm hysteresis high
SAHL	set alarm hysteresis low
SALHT	set alarm limit high temperature
SALLT	set alarm limit low temperature
SAHHT	set alarm hysteresis high temperature
SAHLT	set alarm hysteresis low temperature
SPMIH	set prealarm measuring interval high
SPMIL	set prealarm measuring interval low
SPFH	set prealarm filter high
SPFL	set prealarm filter low
SPLH	set prealarm limit high
SPLL	set prealarm limit low
SPHH	set prealarm hysteresis high
SPHL	set prealarm hysteresis low
SPLHT	set prealarm limit high temperature
SPLLT	set prealarm limit low temperature
SPHHT	set prealarm hysteresis high temperature
SPHLT	set prealarm hysteresis low temperature

Listing – Command-Befehle

CRBAT	command reset battery
CACK	command acknowledge
CSST1	command send status 1
CSST2	command send status 2
CMDC	command make data connection

Safety notes

Each person that is engaged with inauguration and operation of this device, must have read and understood this technical manual and especially the safety notes.



Installation, electrical connection, inauguration and operation of the device must be made by a qualified employee according to the informations in this technical manual and the relevant standards and rules.

The device may only be used within the permitted operation limits that are listed in this technical manual. Every use besides these limits as agreed can lead to serious dangers.

The materials of the device must be chosen resp. checked for suitability to the respective application requirements (contacting substances, process temperature). An unsuitable material can lead to damage, abnormal behavior or destruction of the device and to the resulting dangers.

Check the signal strength of the GSM network before installation. This can be done by using the signal strength indicator of a commercial mobile phone.

At an insufficient network strength a data transmission can be impossible.

At a bad network strength there will be exhausted essentially more battery capacity and this will considerably reduce the run time of the device.

Only suitable batteries may be used. An unsuitable battery can lead to abnormal behavior of the device and to the resulting dangers. The battery connection is polarity protected.

The device should not be operated without a connected antenna resp. should only be used with a suitable antenna. A damaged antenna can lead to serious injury e.g. burning in the case of touching.

The device may not be used in areas where the using of mobile phones is not allowed, e.g. in hospitals or explosive hazardous areas.

Electromagnetically sensitive devices can be interfered in their operation because of the high energetic radio waves at the moment of data transmission.

In the case of an unfavorable configuration of the device there can be caused very high telephone bills. Due to this the using of a prepaid card for the duration of the inauguration is suggested.

The sensors may not used as sole device for prevention of dangerous conditions in machines and plants.

The device meets the legal requirements of all relevant EC directives. **CE**

Installation

Before installing the RDT module, the needed SIM card must be inserted and the used water level sensor must be connected.

Following, the complete measuring system with water level sensor and RDT module can be inserted directly into water level tubes 4" and wider. All further actions can be done in the installed position.

The installation in wider water level tubes is made by using adapter rings that are put into common filler caps.

After inserting the measuring system into the installation the external antenna must be connected. The socket for the connection is positioned at the top side of the RDT module

The construction of the RDT module allows those damage protected flooding up to 3m water column.

When opening the filler cap of the SIM card or the battery cover, avoid the wasting of the internal area of the device with humidity or dirt.

This can lead to abnormal behavior, reduced run time or destruction of the device.

The correct function of the device within the specific technical data can only be guaranteed, if the permitted temperature from – 20°C to +60°C in the area of the RDT module will not be exceeded.

Installation and removal of the SIM card

Before processing a RDT the device must be supplied with a SIM card that is activated for data transmission. Without this card a RDT is not possible.

Before using a SIM card delete all SMS (sent and received) that are stored on it.

Note: In the case of an unfavorable configuration of the device there can be caused very high telephone bills. This can be avoided by using a prepaid card.

The using of a so-called „prepaid SIM card“ is favorable to restrict the costs at an unfavorable device configuration to the charged amount.

When using a prepaid SIM card a regular check of the balance is suggested. Additionally it is mostly necessary to reactivate the balance of a prepaid SIM card regularly (e.g. 1x per year).

For the different defaults and possibilities of charging / reactivation contact the respective telephone provider.

In the case of an unloaded resp. inactive prepaid SIM card a RDT is only limited possible. The measuring data retrieval is possible, if it is controlled by the PC, because the call is not carried out by the RDT module.

An alarming function resp. also a measuring value request from a mobile phone per SMS is no more possible, because the call resp. the recall must be carried out by the RDT module. This is not possible with an unloaded prepaid SIM card.

For using of SIM card the input of the correct PIN code in the software Gerätanager GM–600 bzw. GM–620 is necessary. Without these PIN code a RDT is not possible.

To use the SIM card without the PIN code, this function must be deactivated. This can only be made by a mobile phone or the like, that configures the SIM card code-free.

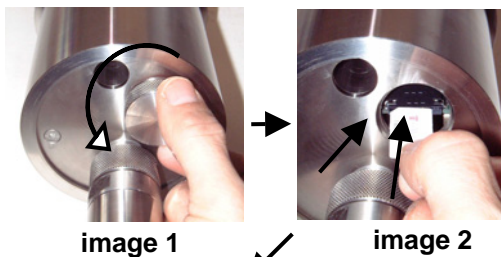

image 1

image 2

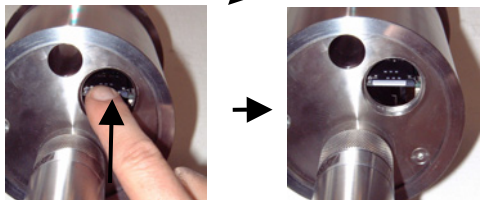

image 3

image 4

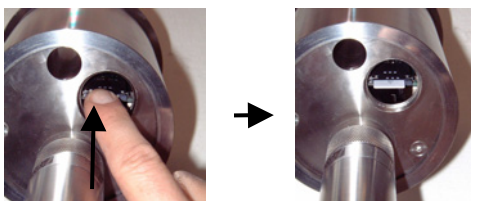

image 5

image 6

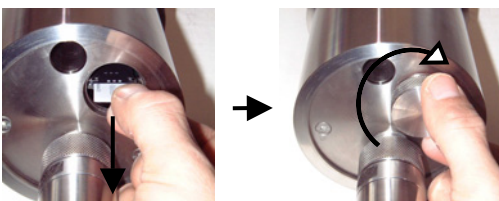

image 7

image 8

For the installation of the SIM card proceed like follows:

Screw completely off completely the filler cap of the SIM card holder at the bottom side of the filler cap counterclockwise (**image 1**). Behind, the SIM card holder is positioned.

Insert the SIM card (**image 2**) with the tapered corner ahead and left into the SIM card holder.

Slide the SIM card till to the stop (**image 3**). The SIM card snaps in the end position in the SIM card holder (**image 4**).

For the removal of the SIM card proceed like follows:

To remove the SIM card, push it by approx. 2mm (**image 5**) and release than the SIM card.

The SIM card will be pushed out approx. 5mm by a spring mechanism (**image 6**) and can now be catch and removed easily (**image 7**).

Put on the filler cap of the SIM card holder and screw it on clockwise (**image 8**). Take into account that only the completely and tighten screwing in of the filler cap guarantees a flood protection of the device up to 3m water column.



When opening the cover of the battery receptacle the wasting of the internal area of the device with humidity or dirt. This can lead to abnormal behavior, reduced run time or destruction of the device.

Connection of a water level sensor

For a complete measuring system with RDT the connection of a water level sensor series Hydrolog to the RDT module is necessary. The sensor will be plugged directly to the RDT module.

Only water level sensors series Hydrolog 500 resp. Hydrolog 1000 may be connected.

The water level sensor Hydrolog 1000 with exchangeable battery must be configured to a RS-232 communication interface, see technical manual Hydrolog 500 / Hydrolog 1000.

Water level sensors series Hydrolog 3000 can not be connected.

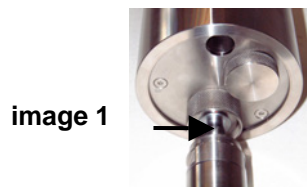

image 1

To connect the water level sensor to the RDT module proceed like follows:

Put the interface socket at the interface head of the water level sensor onto the interface plug of the RDT module.

The nose of the interface plug must grip into the nut of the interface socket (**image 1**). Only by this a fitting together is possible.



image 2

Push the interface plug and the interface socket together till to the stop (**image 2**).

Screw the fixing ring onto the interface head of the water level sensor and tighten it (**image 3**).



If the fixing ring is not screwed on tight, there is the danger, that the water level sensor will break loose from the RDT module and falling down into the water level tube in the case of vibrations or tremors of the system.



image 3

For the releasing of the connection between the water level sensor and the RDT module unscrew completely the fixing ring counterclockwise at first. Now the two devices can be separated by pulling apart.

To protect the contacts put again the cap onto the interface socket and push it till to the stop.

By this the contacts of the interface socket are sealed watertight.

Connection of the antenna:

The connection of the necessary antenna to the RDT module is made at the antenna socket at the top side of the RDT module. Every commercial dual band antenna that fulfills the antenna specifications noted in the technical data's can be connected.

At water level tubes the antenna that is integrated in the filler cap, type AFKG, can be used. This antenna is especially conceived for the use with the RDT module.

In an unfavorable terrain or when operating the RDT module in a building it can be necessary to mount an external antenna in an elevated position or outside the building.

Long antenna cables however can considerably reduce the improvement of the reception.

Therefore the antenna cables of the external antennas must be run the shortest way and beside of this the use of thicker antenna cables e.g. type RG58 instead RG174 is suggested.



image1



image 2

To connect an antenna to the RDT module proceed like follows:

Put in the antenna plug type FME into the antenna socket at the top side of the RDT module and push it tight till to the stop (**image 1**).

Screw on tight the fixing screw clockwise (**image 2**).



image 3

For the sealing of the cable, it is recommended, to slide a shrinkage tube over cable and socket till to the stop (**image 3**) and shrink it by a hot air foehn or the like (**image 4**).



image 4

The antenna socket in the RDT module is constructed water protected up to 3m water column.

By the use of the shrinkage tube also the antenna cable can be protected against water because commercial FME plugs are not constructed waterproof.

Energy supply – battery change

Dependent on environmental conditions e.g. network strength or temperature and also highly depending on the settings like e.g. standby time or frequency of data transmission the inserted battery is differently discharged.

Completely it is possible, each for itself, to send about 3000 SMS or to carry out about 400 data transmission with a data amount of respectively 128kB or to achieve about 400 hours standby time with one lithium battery.

A typically run time of 2 years can be achieved e.g.:

- at a daily standby time once a day for a half hour, or
- at a daily data transmission of a fully stored water level sensor with 128kB memory volume and a measuring interval of ≤ 4 seconds

A typically run time of more than 10 years can be achieved e.g.:

- if the RDT module is only used for rare alarming cases, or
- at a monthly transmission of the data of a water level sensor with 128kB memory volume and a measuring interval or ≥ 2 minutes

The remaining battery capacity is measured internal in the device and is compared with the set available battery capacity of the inserted lithium battery. At an adjustable remaining battery capacity a warning message can be sent. It is suggested to change the battery at a remaining battery capacity lower than 30% in order to guarantee always a sufficient safety function. After a battery change the battery counter must be reset by using the software GM–600 resp. GM–620 in order to have a correct remaining battery capacity measurement. If the reset of the battery counter will not be done, a warning message can be generated, although the inserted battery has enough remaining capacity.

If a lithium battery with a capacity is used that differs from the suggested standard battery, the capacity of the alternative type can be set by the software GM–600 resp. GM–620.

After a long inactive time of the RDT module without resp. with an unloaded battery it can last up to 60 minutes after inserting a new battery before a GSM RDT is already possible, because the internal energy buffer must be reloaded.

The activation of the communication per PC interface can while up to 20 minutes after inserting a new battery.

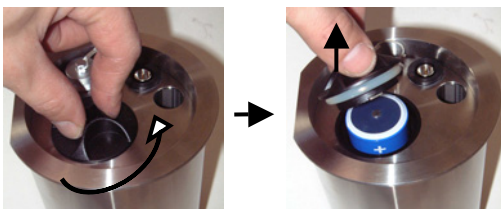

image

image

For a battery change proceed like follows:

Rotate the cap of the battery receptacle at the top side of the housing of the RDT module counterclockwise about 90 degree (quarter turn) (**image 1**) and pull it away (**image 2**).

The battery is lifted out by an implemented spring.

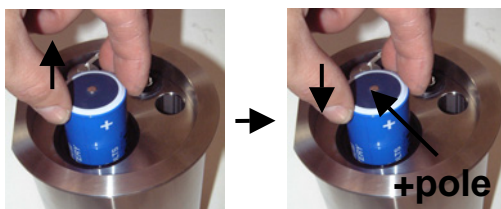

image

image

Remove the old battery (**image 3**).

Insert the new battery with the +pole at the top side into the battery receptacle (**image 4**).

The battery connection is polarity protected.

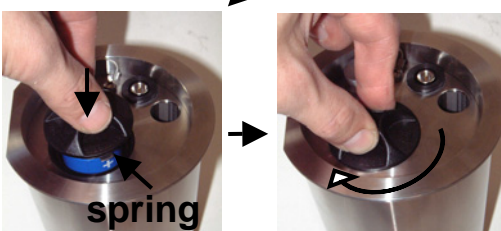

image

image

Push the new battery down to the stop by using the battery receptacle cap against the spring force into the battery receptacle (**image 5**). The two contact springs of the battery receptacle cap must grip into the nuts of the battery receptacle. Rotate the battery receptacle cap clockwise about 90 degree (quarter turn) up to the stop (**image 6**).



When opening the cover of the battery receptacle the wasting of the internal area of the device with humidity or dirt. This can lead to abnormal behavior, reduced run time or destruction of the device.

Maintenance

Except for a possible battery change, the device is free of maintenance.

When using a prepaid SIM card, the regular reload resp. reactivation could be necessary.

Repair

A repair may only be carried out by the manufacturer.

If the device must be sent back for repair, the following informations must be enclosed:

- An exact description of the application.
- The chemical and physical characteristics of the product.
- A short description of the occurred error.

Before returning the device for repair, the following measures must be proceeded:

- All stick product residues must be removed. This is especially important, if the product is unhealthy, e.g. caustic, toxic, carcinogenic, radioactive etc.
- A returning must be refrained, if it is not possible by 100% to remove the unhealthy product completely, because e.g. it is penetrate into cracks or is diffused through plastic.

Technical data**Auxiliary power supply**

Power supply:	Lithium battery	Tadiran SL780 / 3,6V / 16,5Ah / style D
Battery run time:	≥ 3.000 SMS / 400 data transmissions / 400 hours standby, depending on settings and environmental conditions The using of another than the specified battery the run time can differ considerably from these specifications	

Communication GSM

Transmit frequency:	Dual band 900 / 1800 MHz, EGSM
Transmit power:	Class 4 (2 W) at 900 MHz / class 1 (1W) at 1800 MHz
Transmission rate:	9600 Baud, nontransparent
SIM card:	Support of 3V – SIM cards, activated for data transfer

Antenna

Antenna connection:	FME, socket (male)	
Antenna specification:	Type:	dual band 900 / 1800 MHz
	Connector:	plug FME (female)
	Impedance:	50 Ω
	DC Impedance:	0 Ω
	VSWR (Rx / Tx):	max. 1,5 : 1
	Gain:	typ. 0dBi (at least in transmission direction)

Interface – PC / Water level sensor

Type:	RS485 - full-duplex
Transmission rate:	9600 Baud

Clock

Type:	Real time clock
Cycle accuracy:	≤ ±1 minute / month

Materials

Module housing:	CrNi steel
	Antenna socket POM – polyoxymethylene (Delrin®)
	Battery receptacle Cap PE – polyester, glass fiber filled (Nylon®)
Interface plug / socket:	Socket brass nickel plated / chrome plated, insert PBT/PUR, contacts gold plated
Gaskets:	FPM – fluorelastomere (Viton®) NBR – nitril-butadien-rubber Silicone

Environmental conditions

Environmental temperature:	– 20°C...+60°C	
Weight:	2,3 kg	
Protection classification:	IP68 up to 3 mWs	DIN EN 60529
Climatic classification:	4K4H	DIN EN 60721-3-4
Shock classification:	50 g	DIN EN 60068-2-27 (11 ms)
Vibration classification:	20 g	DIN EN 60068-2-6 (10 - 2000 Hz)
EM – compatibility:	EN 301 489 -1 / -7 / DIN EN 55022 / DIN EN 61000-4-2 / -4-3 / -4-5	
Reference conditions:	DIN EN 60770-1 resp. DIN EN 61003-1 T = 25 °C, relative humidity 45...75 %, environmental air pressure 860...1060 kPa	

Dimension drawings

RDT module with water level sensor

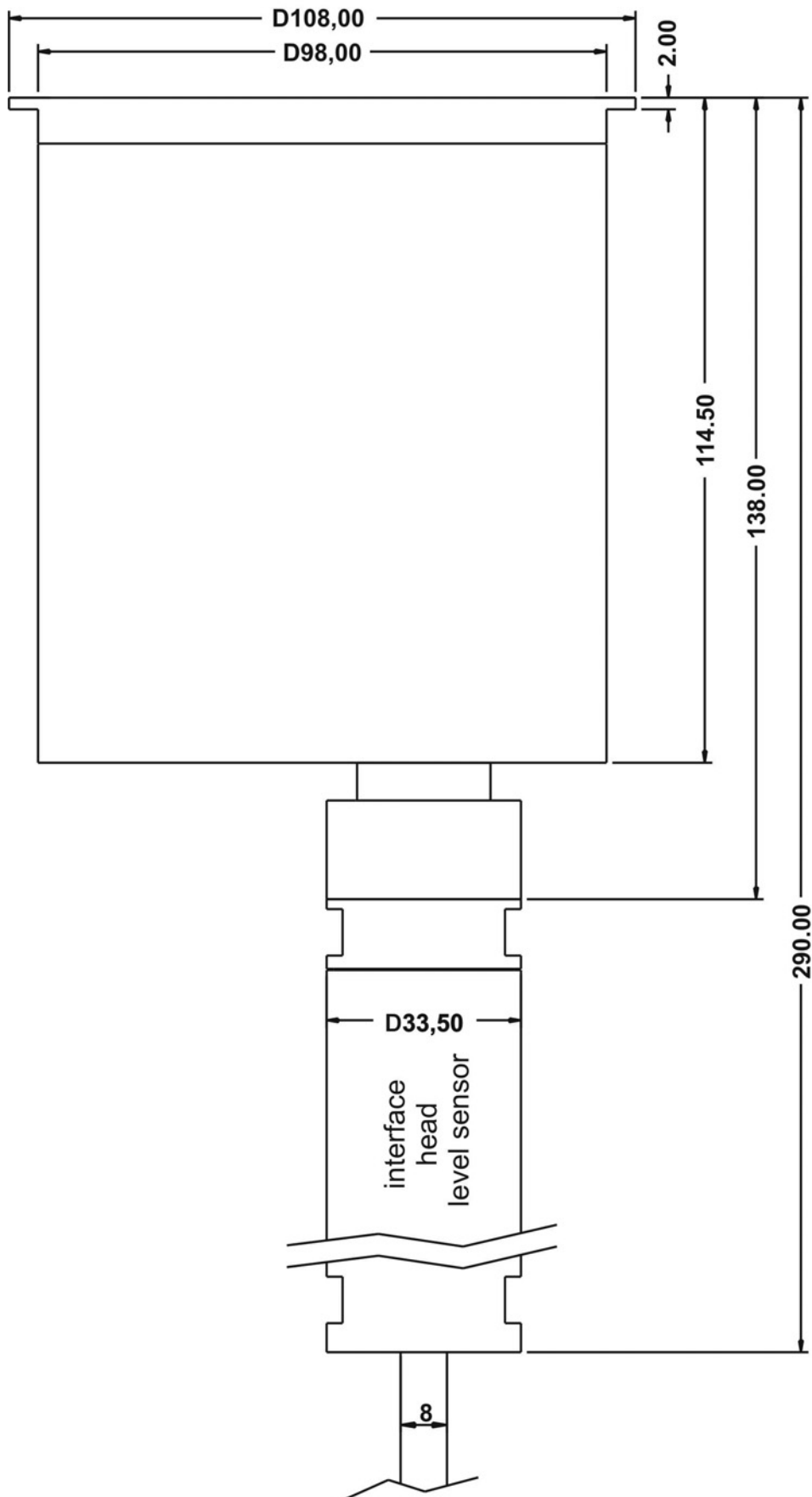

Dimension drawings

RDT module with filler cap G 4"

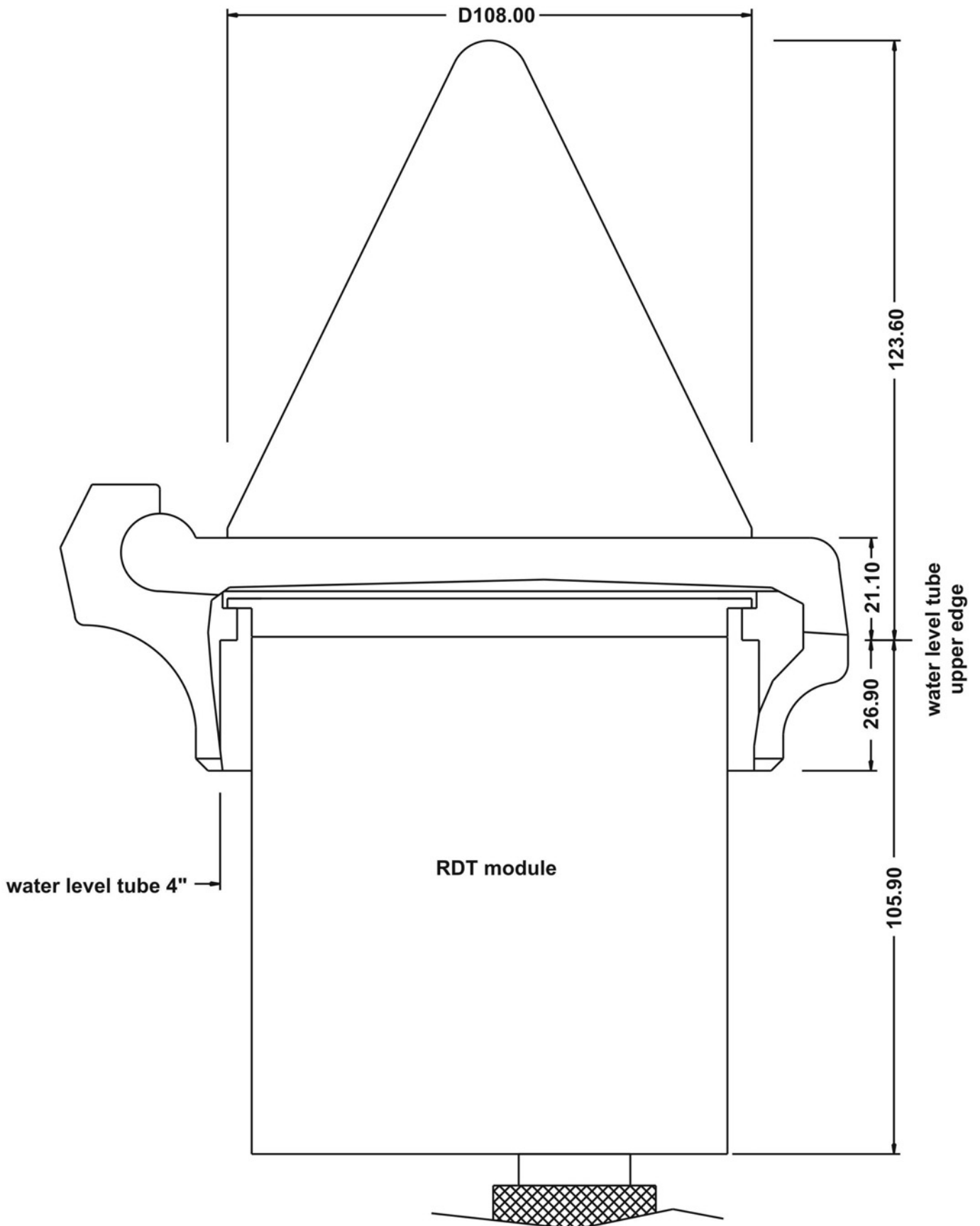

Accessories, not implemented in standard extend of supply

GM-600	Operation and evaluation software for operating system MS WINDOWS® 2000 and higher
GM-620	Operation and evaluation software for operation system with .NET® Framework, e.g. MS WINDOWS® Mobile
STK-RS-1,75m	Interface cable RS232 for PC interface RS 232, cable 1,75m
STK-USB-1,75m	Interface cable USB for PC interface USB, cable 1,75m
TDS RECON	Handheld PC for outdoor-use with operation system MS WINDOWS® Mobile with preinstalled operation and evaluation software GM-620 with RS-232 and USB communication interface
BATGSM	Replacement battery, type Tadiran SL780 / 3,6V / 16,5Ah
AEXTM-2,5m	Magnetic adhesive antenna, length of connecting cable 2,5m
AM - 1000	Hand-held terminal with interface RS232
STK-RSX- 1,75m	Interface transmission cable, length 1,75m necessary for use of AM-1000

Filler cap in foundry aluminium, plastic coated, with 6-edge-seal with integrated antenna and connection plug FME (female)

AFKG 400	G 4"	acc. to DIN EN ISO228-1
AFKG 412	G 4 ½"	acc. to DIN EN ISO228-1
AFKG 500	G 5"	acc. to DIN EN ISO228-1
AFKG 600	G 6"	acc. to DIN EN ISO228-1
SCHVK-6	Key for 6-edge-seal	

Filler cap in foundry aluminium, plastic coated, with 5-edge-security-seal with integrated antenna and connection plug FME (female)

AFKG 400 S	G 4"	acc. to DIN EN ISO228-1
AFKG 412 S	G 4 ½"	acc. to DIN EN ISO228-1
AFKG 500 S	G 5"	acc. to DIN EN ISO228-1
AFKG 600 S	G 6"	acc. to DIN EN ISO228-1
SCHVK-5	Key for 5-edge-secure seal	

Adapter rings for installing the RDT module into wider filler caps

ZR-4-412	4" to 4 ½"
ZR-4-5	4" to 5"
ZR-4-6	4" to 6"