



VISUALIZED DIGITAL COUNTER WITH ONE SET POINT

Type:
LCM61

VISUALIZED DIGITAL 6 DIGITS COUNTER, WITH INPUT FOR SINGLE DIRECTIONAL COUNTS, ONE SET POINT OF INTERVENTION AND IMPULSES TOTALIZER.

The **LCM 61** counter finds application where there is the necessity to visualize and to control, through one programmable set point, mono-directional counts deriving from electromechanical and logical contacts, proximity and encoder.



MAIN FEATURES

- Frontal keyboard in polycarbonate (antiscratch, antioil, antacid).
- IP65 protection degree
- Accessible parameters with key software
- Removable terminals connection.
- Execution DIN 48 x 96.
- Recessed assembly.
- Special retaining brackets.

PROGRAMMABLE PARAMETERS

- One set points
- Reset time
- 2 conversion factors of the impulses
- Input (Slow / Fast)
- Count (Up / Down / Superior)
- Memory
- Reset key
- Decimal Point

TECHNICAL FEATURES

| | |
|---|--|
| • POWER SUPPLY IN ALTERNATE CURRENT | : Single power 24 - 110 - 230 Vac (50 / 60 Hz). |
| • POWER SUPPLY IN DIRECT CURRENT | : Single power 24 Vdc |
| • POWER SUPPLY TOLERANCE | : +10% - 15%. |
| • ABSORPTION | : 2 W - 3 VA. |
| • OPERATING TEMPERATURE | : -5 °C + 55 °C. |
| • CLIMATIC CONDITIONS | : U.R. 95 % at 40 °C (without condensate). |
| • COUNTER AND TOTALIZER VISUALIZATION | : 6 digits, 14mm high |
| • MULTIPLICATION FACTOR M1 OF THE IMPULSES IN INPUT | : Programmable from 0,00001 to 9,9999. |
| • MULTIPLICATION FACTOR M2 OF THE IMPULSES IN INPUT | : Programmable from 1 to 99. |
| • INPUT TYPE | : Suitable for electromechanical contact and NPN or PNP signals |
| • COUNT FREQUENCY FOR LOGICAL SIGNALS | : Up to 15 KHz with Duty Cycle=50%. |
| • MINIMUM TIME FOR COUNT IMPULSES | : 0,25 mSec. |
| • CUT FREQUENCY FOR ELECTROMECHANICAL INPUTS | : About 30 Hz. |
| • AUXILIARY INPUTS POWER SUPPLY | : 24 Vdc - 80 mA available on terminals. |
| • COMMAND INPUTS | : 1 Counter Reset - 1 Inhibit. |
| • OUTPUTS | : 1 relay with operating contacts - capacity 2A - 250Vac. |
| • RELAY RESET | : Manual or automatic with excitation time from 0,1 to 99,9 sec. |
| • PROGRAMMED DATA MEMORY | : static (no battery) |

DESCRIPTION OF THE FRONTAL KEYBOARD

 **YELLOW**

The key '**LEFT ARROW**' in normal operating phase visualizes, blinking, all the programmings executed without the limitation of the insertion code. The time of scansion of the programmings is given from the pressure of the same key. It exits automatically from this phase after 5 sec of the last pressure of the same key.

In programming phase it moves the cursor of the figure towards left of a step, than at the beginning it is on the right side first one on the. At the end it resumes from the first one to right.

 **YELLOW**

The key '**UP ARROW**' in normal operating phase visualizes the totalizer of impulses.

In programming phase it increases the value of the blinking figure.

 **BLUE**

The key '**PRG**' pressed for 2 sec. allows to enter in the programming phase, visualizing on display C.0000.

In the programming phase, pressing key 'PRG' impulsively, it exits from the programming phase. The instrument exits automatically from the programming phase, 60 sec. after the pressure of the last key.

 **RED**

The key '**ENT/RES**' in normal phase of counting has the 'RESET' function, with the modalities to it attributed in the programming phase.

In programming phase it confirms and memorizes the visualized data and passes to the successive function. If it has arrived to list end it resumes from the beginning.

INPUTS / OUTPUTS DESCRIPTION

DC POWER
(inputs 1-2)

24V DC Power Supply of the instrument.

AC POWER
(inputs 3-4)

AC Power Supply of the instrument; it can be to 24 - 110 - 230 VAC according to demand.

24 VDC - 80mA
(inputs 5 - 6)

24 VDC - 80 mA auxiliary Power Supply that the instrument supply to feed Encoder and amplified proximity.

COUNT INPUT
(input 7)

Input of count adapted for electromechanical and logical contacts, encoder and 3 wires amplified proximity, configurable in Positive (PNP) and Negative (NPN) logic.

RESET
(input 8)

Input of RESET that executes the reset visualized count showed on display at the moment of its activation.

INHIBIT
(input 9)

Input of count inhibition: when activated it blocks the count of the normal counter and the totalizer.

RL1
(inputs 11 -12 - 13)

Output of Relay 1, connected to the operation of the Set Point S1. The Common and Normally Opened contacts are available.

DESCRIPTION OF THE LED'S OPERATION

LED 1 (FRONTAL)

It comes activated to the reaching of the Set Points S1.

LED 1 (REAR)

Shows the presence of the impulse's signal in input

SET POINTS PROGRAMMING

For SET POINTS programming access, proceed as follow:

- Press key 'PRG' in impulsive mode; on display appears:

| |
|--------|
| S 1 |
| 999999 |

S.1 = SET POINT 1, main Set Point, programmable between 0 and 999999. If programmed = 0 the Set Point remains excluded and the instrument works like a totalizer and predisposing the count in UP mode.

Key **ENT** confirms the data. In order to exit the programming, press key **PRG**.

PROGRAMMING OF THE OPERATION PARAMETERS

The programmable parameters are divided in two groups and protect with a 4 figures code.

In order to approach the programming, proceed in the following way:

- Press key **PRG** for about 2 sec. On the display appears:

| |
|------|
| Cod |
| 0000 |

GROUP 1 : in order to approach the parameters of group 1, insert code **2357** and press **ENT**

| |
|-------|
| n 1 |
| 10000 |

6 digits multiplier , programmable from 0,1 to 9.9999. This parameter allows to convert the number of the input impulses, showing them on the display in an other format. If it programmed = 0 it comes reprogrammed automatically to 1. If a value lower than 1 is inserted, it obtains the division of the impulses. Es. I want to divide for 25 the impulses in input; calculation 1 : 25 = 0.04.

Attention: the variation of the value of the multiplying modifies automatically the value of the count and the totalizer.

| |
|-------|
| n2 10 |
|-------|

2 digits multiplier, programmable from 1 to 99. This parameter allows to convert the number of the input impulses, showing them on the display in an other format. If it programmed = 0 it comes reprogrammed automatically to 1.

Attention: the variation of the value of the multiplying modifies automatically the value of the count and the totalizer.

| |
|-----------|
| t.r. 99.9 |
|-----------|

t.r. = Automatic Time of Reset, programmable from 0.0 to 99.9 sec. This parameter allows to make to work the instrument in **automatic** mode. When the count arrives to the value of S.1, it automatically resets the count, excites the RL1 relay and it resumes to count without to lose the impulses. The RL1 relay remains excited for the time set up in **t.r.** If the time of reset is programmed = 0 (0.0) the instrument gets ready to works in **manual** mode.

Particular cases: if the set up time **t.r.** is smaller of the time employed from the count to arrive to the values of S.1 or S.2, the relative relays will not never come unactivated.

| |
|------|
| In F |
| In S |

Input Fast - Slow.

This programming allows to predispose the input of count to read signals coming from electromechanical contacts (relay, switches etc.) that introduces false signals, or from logical signals like proximity, encoder, transistor etc.)

In = F. predisposes the instrument in order to read to logical signals up to 15 KHz.

In = S. predisposes the instrument in order to read to electromechanical contacts up to 30 Hz.

| |
|--------|
| Cn UP |
| Cn dn |
| Cn Sp. |

Count UP / DOWN / Superior.

Count = Up: the counter gets ready to visualize the count in increasing way (UP), starting from zero up to the programmed value of set point. To ended count it behave in Manual or Automatic mode like programmed in **t.r.**

Count = dn: the counter gets ready to visualize the count in decreasing way (DOWN), starting from the programmed value of set point to zero. To ended count it behave in Manual or Automatic mode like programmed in **t.r.**

Count = Sp: the counter gets ready to visualize the count in increasing way, starting from zero up to the programmed value of set point. To the attainment of the value of programmed set point it behave as in the Manual count and continues to count the impulses in input.

PROGRAMMING OF THE OPERATION PARAMETERS

The programmable parameters are divided in two groups and protect with a 4 figures code.

In order to approach the programming, proceed in the following way:

- Press key **PRG** for about 2 sec. On the display appears:

| |
|------|
| Cod |
| 0000 |

GROUP 2 : in order to approach the parameters of group 1, insert code **2413** and press **ENT** key

| |
|--------|
| MEM.on |
| MEM.of |

Active or excluded memory.

This parameter allows to program the saving of the current counter value during the power off the instrument.

MEM.on. = memorization of the count during the power off. When power on the instrument the display will visualize the last present value in the power off phase.

MEM.of. = excluded memorization of the count; every time that the instrument comes powered off and then powered on the count comes lost and the instrument restart always from the initial condition.

| |
|--------|
| RES.on |
| RES.of |

RESET Key ON / OFF; this programming enables and disables the RESET function of frontal key RES during the operation of the counter. The disabling does not allow to reset the counter and the totalizer.

RES.on = RESET function of key RES **enabled**

RES.of. = RESET function of key RES **disabled**

| |
|--------|
| d.p. 0 |
| d.p. 5 |

Programming of the Decimal Point of the Counter and the Totalizer.

This programming allows to add a decimal point to the visualization on the 5 digits, in order to obtain counts with various resolutions.

d.p. = 0 Decimal Point excluded; visualization 999999

d.p. = 1 Decimal Point on the second display from right; visualization 99999,9

d.p. = 2 Decimal Point on the third party display from right; visualization 9999,99

d.p. = 3 Decimal Point on the quarter display from right; visualization 999,999

d.p. = 4 Decimal Point on fifth display from right; visualization 99,9999

d.p. = 5 Decimal Point on sixth display from right; visualization 9,99999

Attention, the Decimal Point is only fictitious, it doesn't realize any conversion.

| |
|------|
| Ou.1 |
| Ou.1 |

Programming of the OUTPUT 1 RL1. This parameter allows to activate the RL1 relay to the beginning **_l** or to the end **l_** of the count.

Ou.1 = the Activation of the RL1 relay to end of count

Ou.1 = the Activation of the RL1 relay to beginning of count

| |
|--------|
| AP. P. |
| AP. r. |

Activation mode of the programmed parameters.

With this programming is possible to activate the executed programmings directly to the exit of the programming or, when exited of the programming, after a RESET (with frontal key or from rear input)

A.P. = P. Activation of the parameters to the exit of the programming.

A.P. = r. Activation of the parameters to the exit of the programming after a RESET.

Pressing the key  the totalizer of impulses will be visualized for 5 sec.

| |
|--------|
| tot. |
| 999999 |

The totalizer visualizes all the impulses that the instrument counts from its input IN1. It can be resetted through frontal key RES only or from RESET input when it is visualized on the display.

DECLARATION OF 'CE' CONFORMITY

CE NORMATIVE CONFORMITY

Borgolavezzaro, September, 8th 2000

The building firm: **CET Control System S.a.s.**

Head office: **Strada Statale 211, Km 53,3
28071 Borgolavezzaro (No) ITALIA
Tel. 0039 - (0)321 - 885301 Fax. 0039 - (0)321 - 885560**

declare that the products:

type : **Electronic Counter**

model: **LCM 61**

use class: **Industrial**

are in conformity with the following normatives:



**EN55011
ENV50141
ENV50204
EN61000-4-2
EN61000-4-4**

The manufacturing : **CET s.a.s.**

C.E.T. S.A.S.
di FRANCHINO & C.
S.S. 211 - TEL. 0321 - 885188 - 885301
28071 BORGOLAVEZZARO
C. I. • part. IVA 00141780031

Signature

CONNECTIONS

NPN PROGRAMMING  PNP PROGRAMMING 

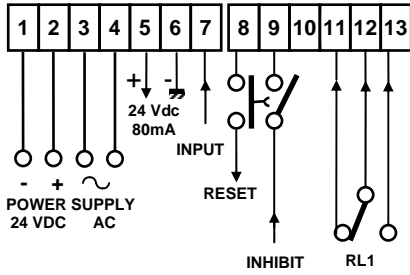

INPUT SIGNALS

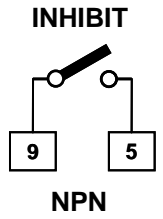
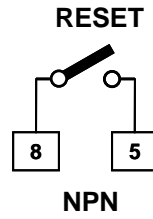
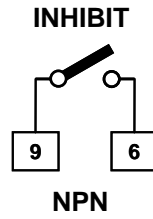
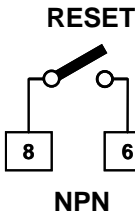
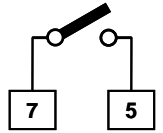
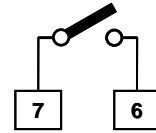
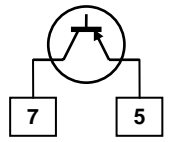
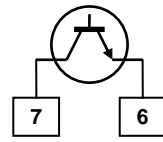
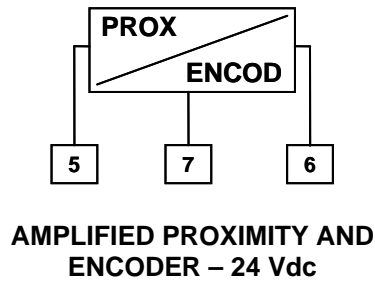

OVERALL DIMENSIONS (mm)

FRONT

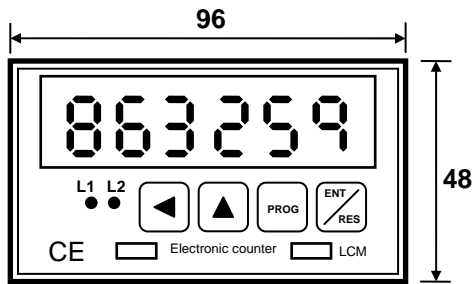

SIDE

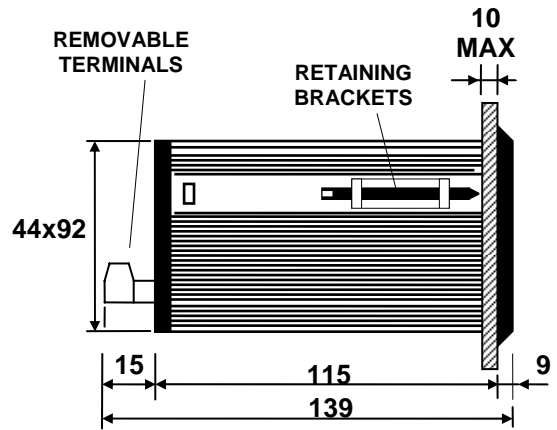

REAR

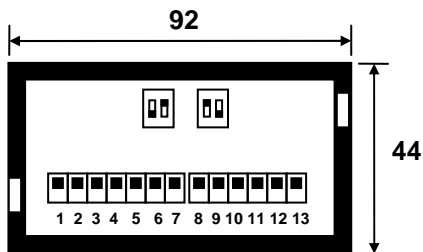

DRILL TEMPLATE

